

Leica DISTO™ X310

The original laser distance meter



- when it has to be **right**

Leica
Geosystems

Instrument Set-up	2
Introduction	2
Overview	2
Display	3
Insert batteries	3
Operations	4
Switching ON/OFF	4
Clear	4
Message Codes	4
Adjusting measuring reference / tripod	4
Multifunctional endpiece	5
Distance unit setting	5
Tilt unit setting	5
Timer (automatic release)	5
Beep ON/OFF	6
Illumination ON/OFF	6
Keypad lock ON	6
Keypad lock OFF	6
Measuring Functions	7
Measuring single distance	7
Permanent / Minimum-Maximum measuring	7
Add / Subtract	7
Area	8
Volume	9
Triangular area	10
Pythagoras (3-point)	11
Pythagoras (partial height)	12
Stake out	13
Smart Horizontal Mode	14
Height tracking	14
Memory (20 last displays)	15

Delete Memory	15
---------------------	----

Calibration	16
--------------------------	----

Calibration of tilt sensor (Tilt Calibration)	16
---	----

Technical Data	17
-----------------------------	----

Message Codes	18
----------------------------	----

Care	18
-------------------	----

Warranty	18
-----------------------	----

Safety Instructions	18
----------------------------------	----

Areas of responsibility	18
-------------------------------	----

Permitted use	19
---------------------	----

Prohibited use	19
----------------------	----

Hazards in use	19
----------------------	----

Limits of use	19
---------------------	----

Disposal	19
----------------	----

Electromagnetic Compatibility (EMC)	20
---	----

Laser classification	20
----------------------------	----

Labelling	20
-----------------	----

Introduction



The safety instructions and the user manual should be read through carefully before the product is used for the first time.

The person responsible for the product must ensure that all users understand these directions and adhere to them.

The symbols used have the following meanings:

WARNING

Indicates a potentially hazardous situation or an unintended use which, if not avoided, will result in death or serious injury.

CAUTION

Indicates a potentially hazardous situation or an unintended use which, if not avoided, may result in minor injury and/or appreciable material, financial and environmental damage.



Important paragraphs which must be adhered to in practice as they enable the product to be used in a technically correct and efficient manner.

Overview

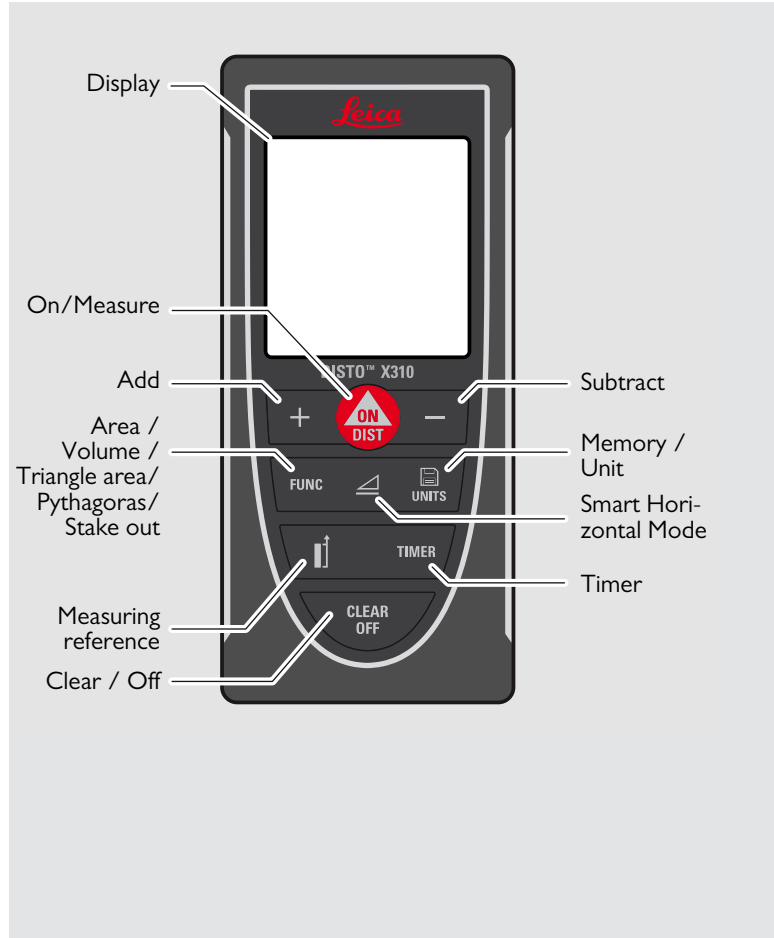

Display

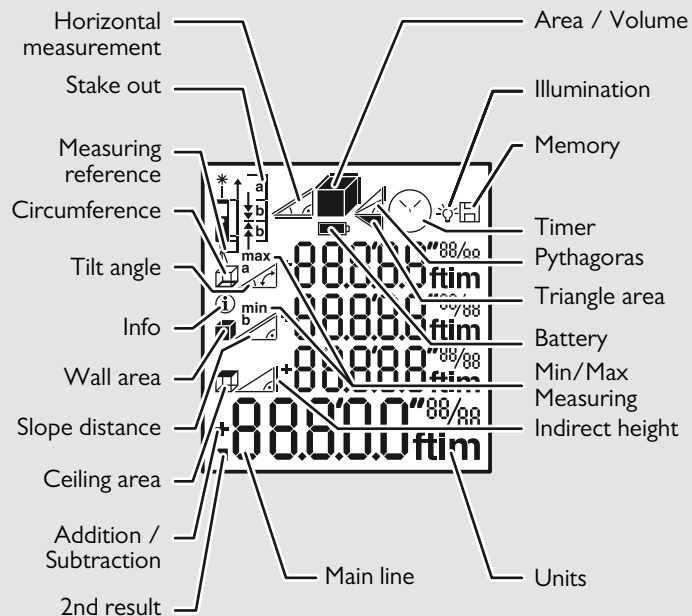

Insert batteries

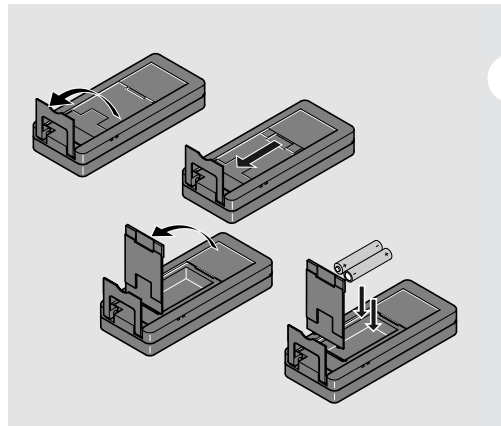

i

To ensure a reliable use, do not use zinc-carbon batteries. Change batteries when battery symbol is flashing.

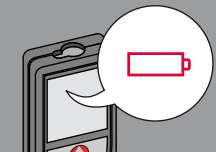

Switching ON/OFF

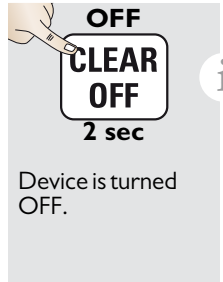

ON
ON
DIST

OFF
CLEAR
OFF
2 sec

i Press ON button 2 sec to start continuous laser mode.

Clear

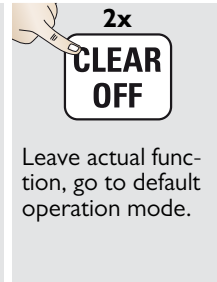
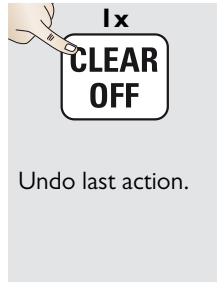

1x
CLEAR
OFF

Undo last action.

2x
CLEAR
OFF

Leave actual function, go to default operation mode.

Message Codes

If the message "InFo" appears with a number, observe the instructions in section "Message Codes".
Example:



Adjusting measuring reference / tripod

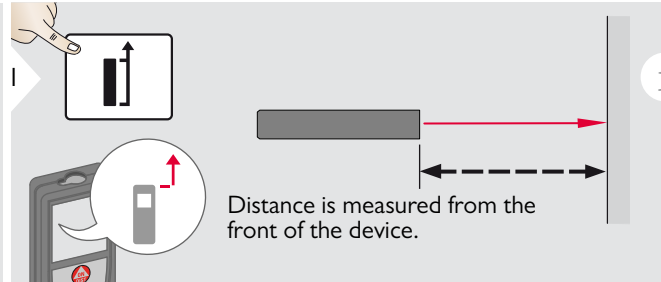

i Press button 2 sec and reference from front is set permanently.

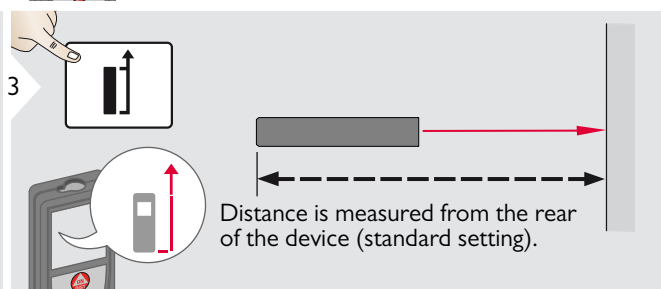
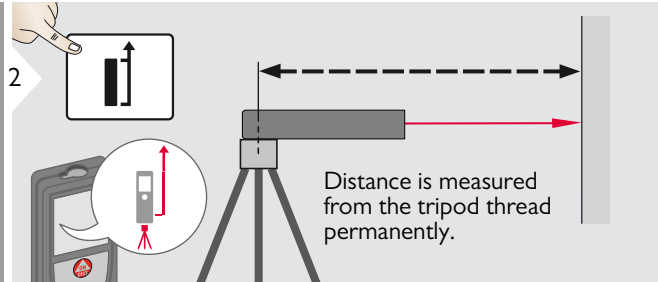

Multifunctional endpiece

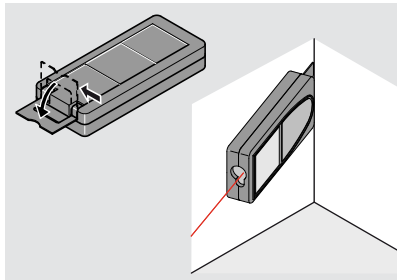
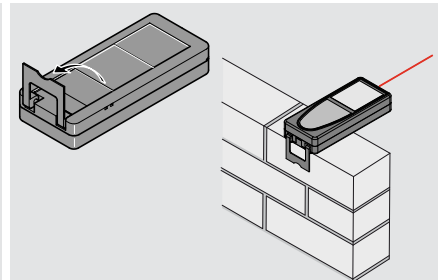

i The orientation of the endpiece is automatically detected and the zero point is accordingly adjusted.

Distance unit setting

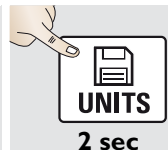

2 sec

Switch between the following units:

0.000 m	0.00 ft
0.0000 m	0'00" 1/32
0.00 m	0.00 in
	0 in 1/32

Tilt unit setting

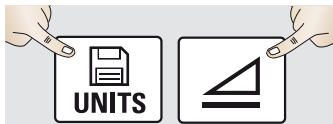

2 sec
simultaneously

Switch between the following units:

0.0 °
0.0 %

Timer (automatic release)

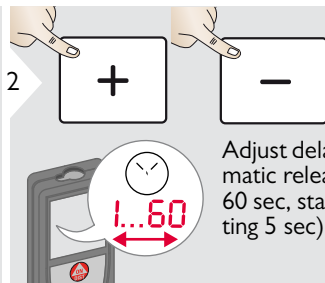
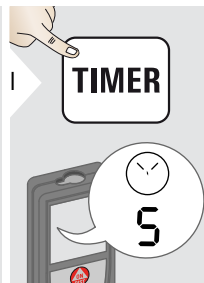

Adjust delay of automatic release (max. 60 sec, standard setting 5 sec)

i Once the key is released with the laser activated, the remaining seconds until the measurement is displayed in a countdown. The delayed release is recommended for precise aiming e.g. at long distances. It avoids shaking of the device when pressing the measurement key.

Beep ON/OFF

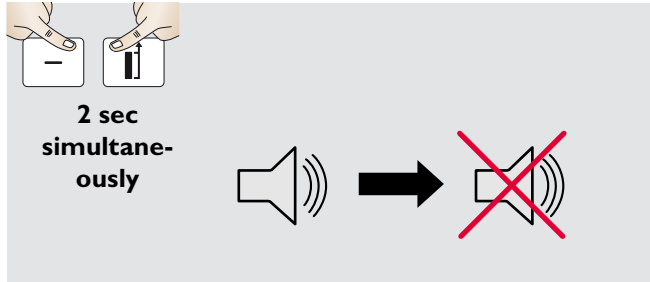

Illumination ON/OFF

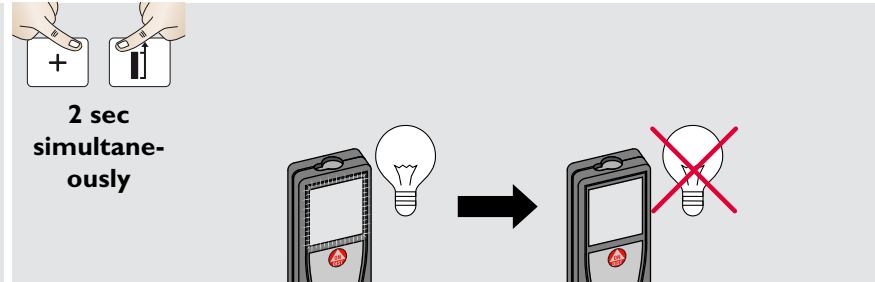

Keypad lock ON

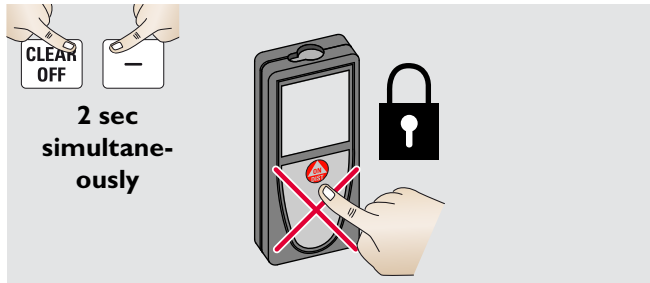

Keypad lock OFF

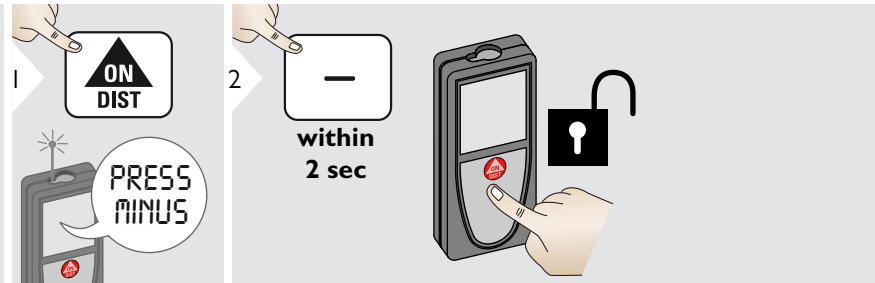

Measuring single distance

1 **ON DIST**

2 Aim active laser at target.

3 **ON DIST** 8.532 m

i Target surfaces: Measuring errors can occur when measuring to colourless liquids, glass, styrofoam or semi-permeable surfaces or when aiming at high gloss surfaces. Against dark surfaces the measuring time increases.

Permanent / Minimum-Maximum measuring

1 **ON DIST** 2 sec

2 min. max. The minimum and maximum distance measured is displayed (min, max.). The last value measured is displayed in the main line.

3 **ON DIST** max min 8.532 m

Used to measure room diagonals (maximum values) or horizontal distance (minimum values)

i Stops permanent / minimum-maximum measuring.

Add / Subtract

1 **ON DIST** 7.332 m

2 + - The next measurement is added to the previous one. The next measurement is subtracted from the previous one.

3 **ON DIST** 7.332 m 12.847 m

i The result is shown in the main line and the measured value above. This process can be repeated as required. The same process can be used for adding or subtracting areas or volumes.

Area

1 **FUNC**

2 Aim laser at first target point.

3 **ON DIST**

4 Aim laser at second target point.

5 **ON DIST**
24.352 m²

i

The result is shown in the main line and the measured value above.
 Partial Measurements:
 Press + or - after starting the first measurement. Measure and add or subtract distances. Finish with DIST. Measure 2nd length.

6 **FUNC**
2 sec

19.823 m — Circumference

24.352 m² — Area

Volume

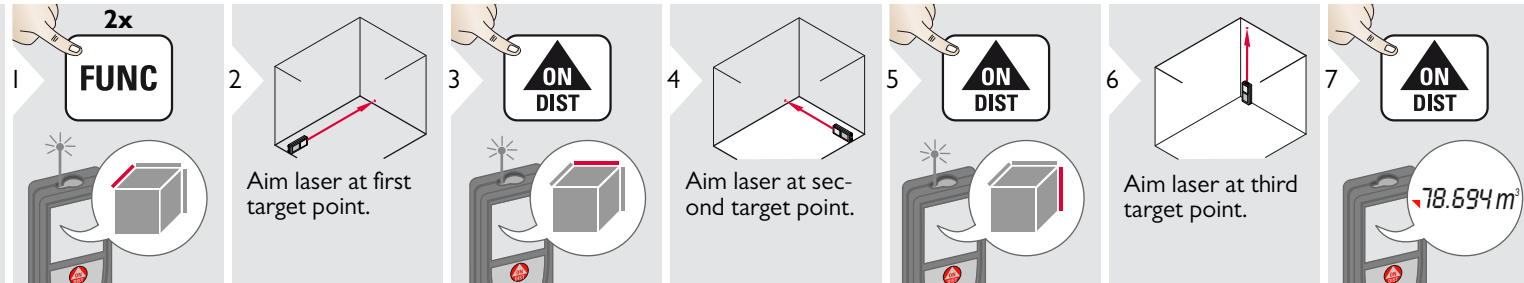

i

The result is shown in the main line and the measured value above.

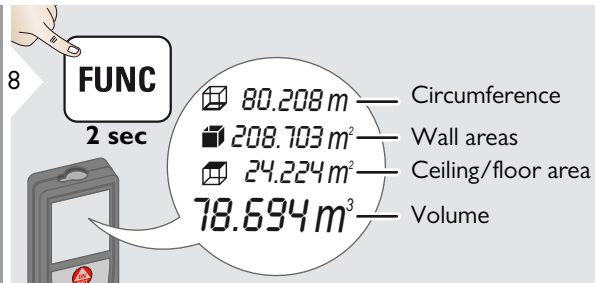

Triangular area

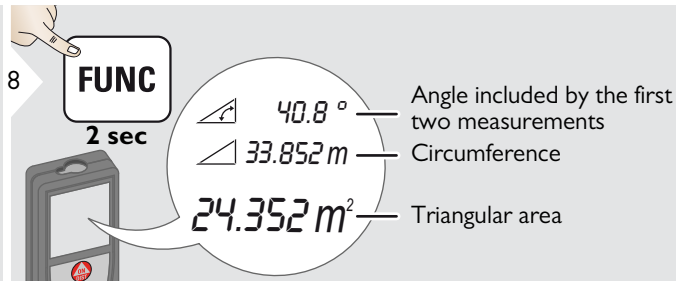
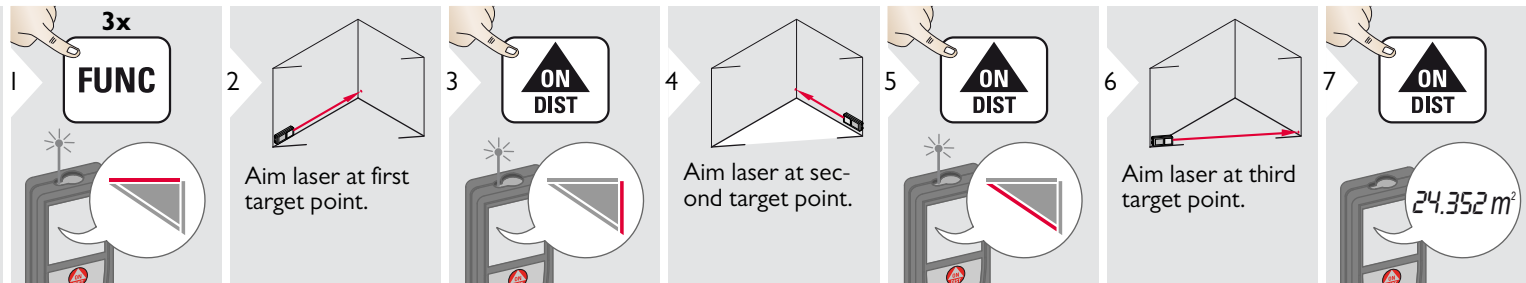

Pythagoras (3-point)

1 **4x**
FUNC

2 Aim laser at upper point.

3 **ON DIST**

4 Aim laser at rectangular point.

5 **ON DIST**

6 Aim laser at lower point.

7 **ON DIST**
8.294 m

i The result is shown in the main line and the measured distance above.
Pressing the measuring key for 2 sec in the function activates automatically Minimum or Maximum measurement.

Pythagoras (partial height)

1 **5x**
FUNC

2 Aim laser at upper point.

3 **ON**
DIST

4 Aim laser at 2nd point.

5 **ON**
DIST

6 Aim laser at rectangular point.

7 **ON**
DIST
2.602 m

i The result is shown in the main line and the measured distance above. Pressing the measuring key for 2 sec in the function activates automatically Minimum or Maximum measurement.

Stake out

1

Two different distances (a and b) can be entered to mark off defined lengths.

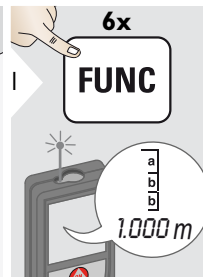
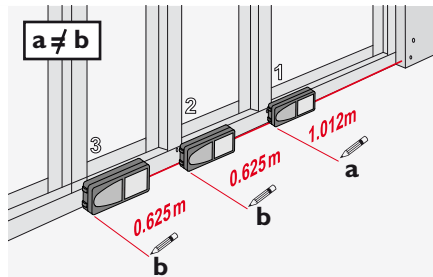
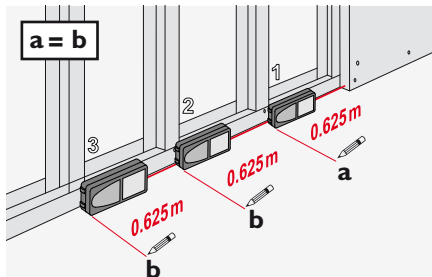

2



Adjust value "a".



3



Approve value "a".

4



Adjust value "b".



5



Approve value "b" and start measurement.

6

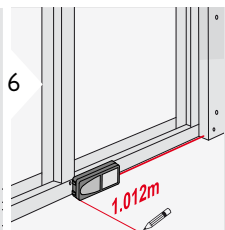

Move device slowly along the stake-out line. The distance to the next stake out point is displayed.

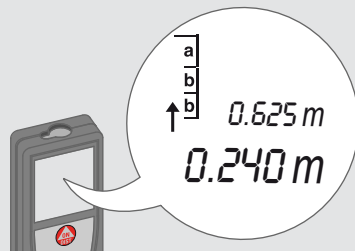

0.240 m is missing up to next 0.625 m distance.

1

When approaching a stake out point to less than 0.1 m the instrument starts to beep. The function can be stopped by pressing the CLEAR/OFF button.

Smart Horizontal Mode

1

2 Aim laser at target.

3

ON DIST

40.8° — α
 5.204 m — X
 0.032 m — Y
 4.827 m — Z

(up to 360° and a transverse tilt of $\pm 10^\circ$)

i Press key again to switch off horizontal measurement.

Height tracking

i This function displays continuously the tracking height if the device is turned on a tripod. No 2nd distance measuring is needed as only the angle is automatically measured.

1

2

3

ON DIST

Aim laser at lower point.

4

Aim laser at upper points and angle/height tracking starts automatically.

5

40.8° — α
 6.932 m — X
 30.2° — β = Tracking angle
 9.827 m — Y = Tracking height if device is turned on tripod

6

ON DIST

Stops Height tracking and displays last measurement.

Memory (20 last displays)

1



UNITS



20 last displays are displayed.

2

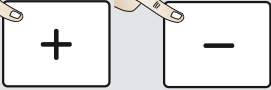

+ **-**



1...20
8.294 m

Navigates through 20 last displays.



UNITS

2 sec

The value from the main line can be used for further calculations.

Delete Memory

3



CLEAR OFF



UNITS

2 sec
simultaneously

Memory is completely deleted.

Calibration of tilt sensor (Tilt Calibration)

1



CLEAR OFF

2 sec simultaneously



MEAS 1
HOR
CAL

2

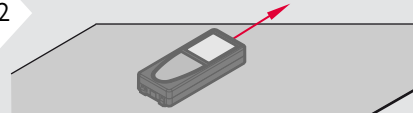

Place device on absolutely flat surface.

3



ON DIST



MEAS 2
turn
180°

4

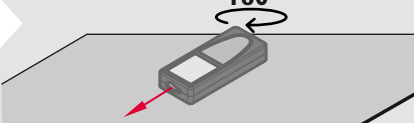

180°

Turn the device horizontally by 180° and place it again on absolutely flat surface.

5



ON DIST



MEAS 3
VER
CAL

6

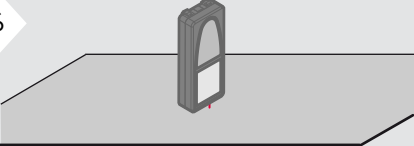

Place device on absolutely flat surface.

7



ON DIST



MEAS 4
turn
180°

8

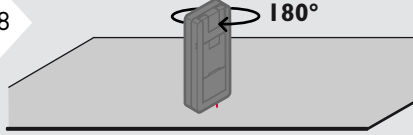

180°

Turn the device horizontally by 180° and place it again on absolutely flat surface.

9



ON DIST



OK
CAL

i After 2 sec the device goes back to the normal mode.

Distance measurement	
Typical Measuring Tolerance*	± 1.0 mm / ~1/16" ***
Maximum Measuring Tolerance**	± 2.0 mm / 0.08 in ***
Range at Leica target plate GZM26	150 m / 490 ft
Typical Range*	120 m / 390 ft
Range at unfavourable condition ****	80 m / 260 ft
Smallest unit displayed	0.1 mm / 1/32 in
Power Range Technology™	yes
Ø laser point at distances	6 / 30 / 60 mm (10 / 50 / 100 m)
Tilt measurement	
Measuring tolerance to laser beam*****	± 0.2°
Measuring tolerance to housing*****	± 0.2°
Range	360°
General	
Laser class	2
Laser type	635 nm, < 1 mW
Protection class	IP65 (dust tight and jet water protected)
Autom. laser switch off	after 90 s
Autom. power switch-off	after 180 s
Battery durability (2 x AAA)	up to 5000 measurements
Dimension (H x D x W)	122 x 55 x 31 mm 4.80 x 2.17 x 1.22 in
Weight (with batteries)	155 g / 4.98 oz
Temperature range:	
- Storage	-25 to 70 °C -13 to 158 °F
- Operation	-10 to 50 °C 14 to 122 °F

* applies for 100 % target reflectivity (white painted wall), low background illumination, 25 °C

** applies for 10 to 500 % target reflectivity, high background illumination, - 10 °C to + 50 °C

*** Tolerances apply from 0.05 m to 10 m with a confidence level of 95%. The maximum tolerance may deteriorate to 0.1 mm/m between 10 m to 30 m and to 0.20 mm/m for distances above 30 m

**** applies for 100 % target reflectivity, background illumination of approximately 30'000 lux

***** after user calibration. Additional angle related deviation of +/- 0.01° per degree up to +/-45° in each quadrant. Applies at room temperature. For the whole operating temperature range the maximum deviation increases by +/-0.1°.

i For accurate indirect results, the use of a tripod is recommended. For accurate tilt measurements a transverse tilt should be avoided.

Functions	
Distance measuring	yes
Min/Max measuring	yes
Permanent measuring	yes
Stake-out	yes
Addition/Subtraction	yes
Area	yes
Triangle area	yes
Volume	yes
Painter function (area with partial measurement.)	yes
Pythagoras	3-point, partial height
Smart Horizontal Mode / Indirect height	yes
Height tracking	yes
Memory	20 displays
Beep	yes
Illuminated display	yes
Multifunctional endpiece	yes

If the message **Error** does not disappear after switching on the device repeatedly, contact the dealer.

If the message **InFo** appears with a number, press the Clear button and observe the following instructions:

No.	Cause	Correction
156	Transverse tilt greater than 10°	Hold the instrument without any transverse tilt.
162	Calibration mistake	Make sure, the device is placed on a absolutely horizontal and flat surface. Repeat the calibration procedure. If the mistake still occurs, contact your dealer.
204	Calculation error	Perform measurement again.
252	Temperature too high	Let device cool down.
253	Temperature too low	Warm device up.
255	Received signal too weak, measuring time too long	Change target surface (e.g. white paper).
256	Received signal too high	Change target surface (e.g. white paper).
257	Too much background light	Shadow target area.
258	Measurement outside of measuring range	Correct range.
260	Laser beam interrupted	Repeat measurement.

- Clean the device with a damp, soft cloth.
- Never immerse the device in water.
- Never use aggressive cleaning agents or solvents.

Warranty

Lifetime Manufacturer's Warranty

Warranty coverage for the entire usage time of the product according to Leica Geosystems International Limited Warranty. Free of charge repair or replacement for all products that suffer defects as a result of faults in materials or manufacturing, for the entire life of the product.

3 Years no Cost

Guaranteed service should the product become defective and require servicing under normal conditions of use, as described in the user manual, at no additional charge.

To receive the "3 years no cost" period, the product must be registered at www.leica-geosystems.com/registration within 8 weeks of the purchase date. If the product is not registered, a "2 years no cost" period applies.

The person responsible for the instrument must ensure that all users understand these directions and adhere to them.

Areas of responsibility

Responsibilities of the manufacturer of the original equipment:

Leica Geosystems AG
Heinrich-Wild-Strasse
CH-9435 Heerbrugg
Internet: www.disto.com

The company above is responsible for supplying the product, including the User Manual in a completely safe condition.

The company above is not responsible for third party accessories.

Responsibilities of the person in charge of the instrument:

- To understand the safety instructions on the product and the instructions in the User Manual.
- To be familiar with local safety regulations relating to accident prevention.
- Always prevent access to the product by unauthorised personnel.

Permitted use

- Measuring distances
- Tilt measurement

Prohibited use

- Using the product without instruction
- Using outside the stated limits
- Deactivation of safety systems and removal of explanatory and hazard labels
- Opening of the equipment by using tools (screwdrivers, etc.)
- Carrying out modification or conversion of the product
- Use of accessories from other manufacturers without express approval
- Deliberate dazzling of third parties; also in the dark
- Inadequate safeguards at the surveying site (e.g. when measuring on roads, construction sites, etc.)
- Deliberate or irresponsible behaviour on scaffolding, when using ladders, when measuring near machines which are running or near parts of machines or installations which are unprotected
- Aiming directly in the sun

Hazards in use

WARNING

Watch out for erroneous measurements if the instrument is defective or if it has been dropped or has been misused or modified. Carry out periodic test measurements. Particularly after the instrument has been subject to abnormal use, and before, during and after important measurements.

CAUTION

Never attempt to repair the product yourself. In case of damage, contact a local dealer.

WARNING

Changes or modifications not expressly approved could void the user's authority to operate the equipment.

Limits of use

-  Refer to section "Technical data". The device is designed for use in areas permanently habitable by humans. Do not use the product in explosion hazardous areas or in aggressive environments.

Disposal

CAUTION

Flat batteries must not be disposed of with household waste. Care for the environment and take them to the collection points provided in accordance with national or local regulations.

The product must not be disposed with household waste.

Dispose of the product appropriately in accordance with the national regulations in force in your country.



Adhere to the national and country specific regulations.

Product specific treatment and waste management can be downloaded from our homepage.

Electromagnetic Compatibility (EMC)

WARNING

The device conforms to the most stringent requirements of the relevant standards and regulations.

Yet, the possibility of causing interference in other devices cannot be totally excluded.

Laser classification

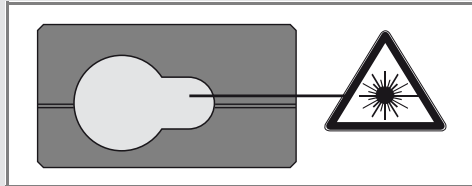

The device produces visible laser beams, which are emitted from the instrument:
It is a Class 2 laser product in accordance with:

- IEC60825-1 : 2014 „Radiation safety of laser products“

Laser Class 2 products:

Do not stare into the laser beam or direct it towards other people unnecessarily. Eye protection is normally afforded by aversion responses including the blink reflex.

WARNING

Looking directly into the beam with optical aids (e.g. binoculars, telescopes) can be hazardous.

CAUTION

Looking into the laser beam may be hazardous to the eyes.

Description	Value
Wavelength	620 - 690 nm
Maximum radiant output power for classification	< 1 mW
Pulse duration	> 400 ps
Pulse repetition frequency	320 MHz
Beam divergence	0.16 x 0.6 mrad

Labelling

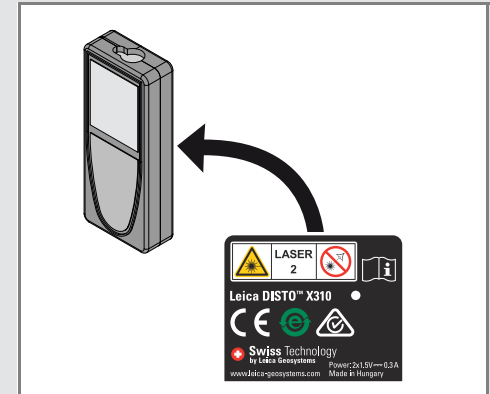

Subject to change (drawings, descriptions and technical data) without prior notice.



Leica Geosystems AG, Heerbrugg, Switzerland has been certified as being equipped with a quality system which meets the International Standards of Quality Management and Quality Systems (ISO standard 9001) and Environmental Management Systems (ISO standard 14001).

Total Quality Management - Our commitment to total customer satisfaction. Ask your local Leica Geosystems agent for more information about our TQM program.

Copyright Leica Geosystems AG, Heerbrugg,
Switzerland 2017
Original text (788479e EN)

Pat. No.: WO 9427164, WO 9818019, WO 0244754, WO 0216964,
US 5949531, EP 1195617, US 7030969, WO 03104748,
Patents pending

Leica Geosystems AG
CH-9435 Heerbrugg
(Switzerland)
www.disto.com

- when it has to be **right**

Leica
Geosystems